

CRX20

_REV14



DESIGN
NATALINO MALASORTI



CRX20/CROSS

AISI 316/L STAINLESS STEEL

Gruppo miscelatore termostatico a parete per vasca/doccia con stop valve, deviatore apri/chiedi a 2/3 vie e doccino

Wall mounted thermostatic mixer set for bath/shower with integrated stop valve, 2/3 way shut-off diverter and hand shower

PRODOTTI CORRELATI / RELATED PRODUCTS

FRE74 - MIL91

- Possibilità di installazione a 180°
Installation possibility at 180°
- Prodotto che necessita di parte incasso
Product that needs built-in part
- Staffa ausiliaria per cartongesso / fibrogesso
Auxiliary bracket for plasterboard / fiber-board structures

MANUTENZIONE / MAINTENANCE

NON UTILIZZARE DO NOT USE		acido clorico e muriatico chloric and muriatic acid
		acido fluoridrico hydrofluoric acid
		ipoclorito di sodio chlorine bleach
UTILIZZARE TO USE		sapone a PH neutro neutral PH soap

Questi disegni sono proprietà di CEADDESIGN SRL s.u. pertanto non potranno essere utilizzati e/o comunicati a terzi, anche in forma parziale, senza preventiva autorizzazione. CEADDESIGN SRL s.u. si riserva il diritto di apportare modifiche ai disegni al fine di migliorare il prodotto.

CEADDESIGN SRL s.u. has the property rights on these drawings, therefore they cannot be used and/or transferred to third party, even in partial form, without any prior authorization. Furthermore CEADDESIGN SRL s.u. reserves the right to apply any change to these drawings in order to upgrade the product.

CEA

ceadesign.it

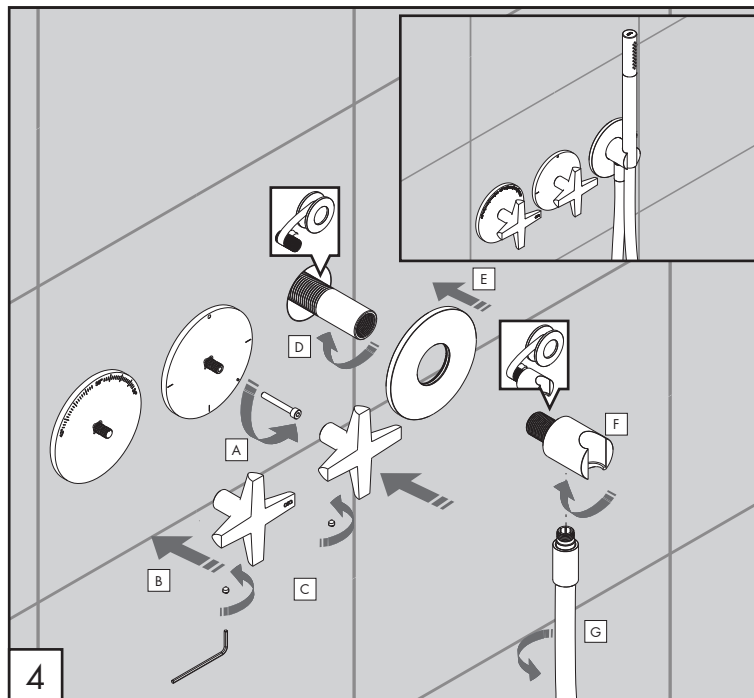
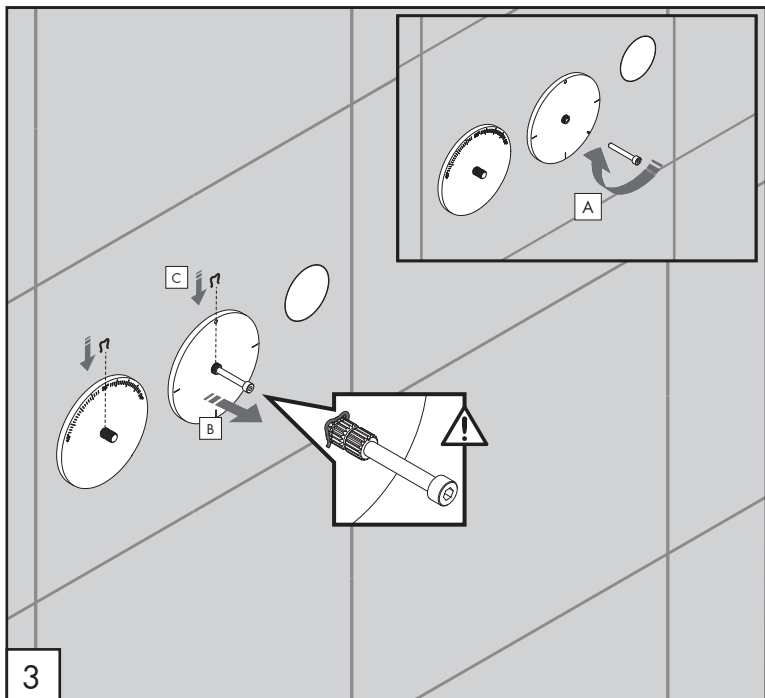
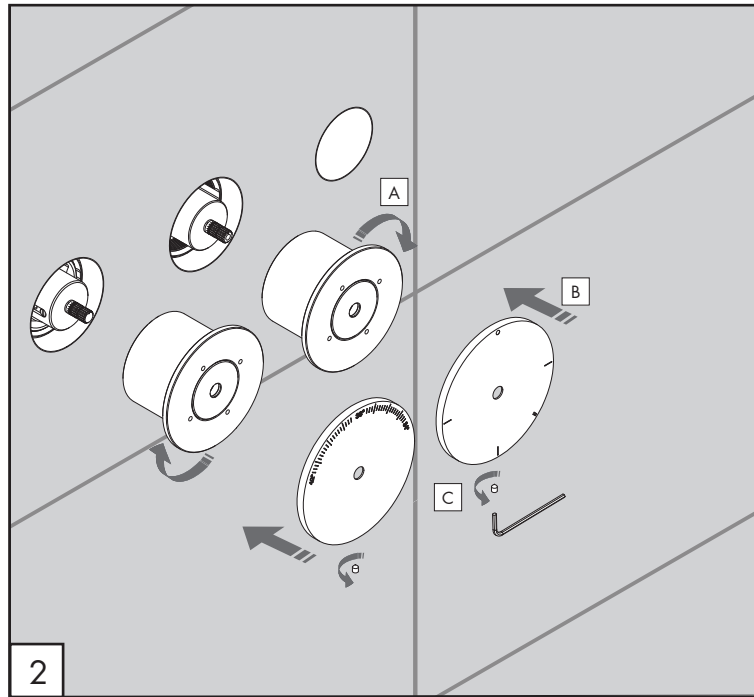
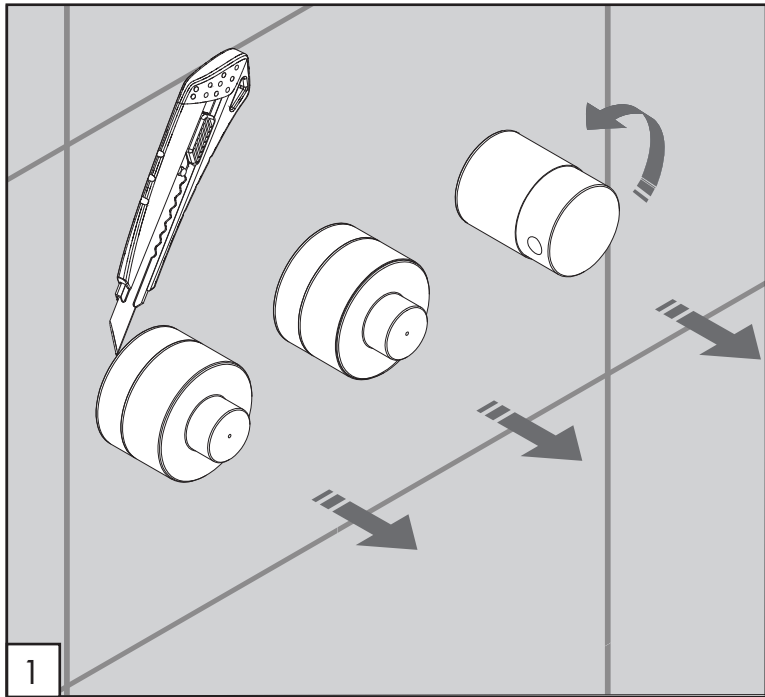

CRX20

_REV14



AVVERTENZE TECNICHE

Risciacquare bene le tubazioni prima del montaggio ed evitare sbalzi di pressione fra i raccordi d'acqua fredda e d'acqua calda. In caso di pressioni statiche superiori a 5 bar si raccomanda l'installazione di un riduttore di pressione per evitare danni alla cartuccia.

TECHNICAL WARNINGS

The pipes have to be rinsed thoroughly before installation. Avoid pressure differences between hot and cold water supply. Use of a pressure reducer when static pressure is higher than 5 bar to avoid damage of the cartridge.

TECHNISCHE WARNUNG

Spülen Sie die Leitungen vor dem Einbau und verhindern Sie Wasserdruckwechsel zwischen kalt und warm Wasserverbindungen. Wenn Wasserdruck größer als 5 bar ist, bitte reduzieren Sie den Systemdruck, um Beschädigung der Kartusche zu verhindern.

ADVERTENCIA TÉCNICA

Los tubos tienen que ser enjuagados a fondo antes de la instalación. Evitar grandes diferencias de presión entre las conexiones de agua caliente y fría. En caso de presión estática mayor de 5 bar, se recomienda el uso de un adaptador de presión para evitar daños en el cartucho.

ADVERTISSEMENTS TECHNIQUES

Rincer les tuyaux avant l'installation. Éviter des grandes différences de pression entre l'eau froide et chaude.

En cas de pressions statique de plus de 5 bar, nous vous recommandons d'installer un réducteur de pression pour éviter des dommages à la cartouche.

PORTATE / FLOW RATE

BAR	uscita 1 / outlet 1		uscita 3 / outlet 3	
	l/min	gpm	l/min	gpm
1	11,2	2.9	11,7	3.1
2	15,8	4.2	16,6	4.4
3*	19,2	5.1	20,2	5.3
4	22,0	5.8	23,3	6.2
5	24,9	6.6	26,1	6.9

BAR	uscita 2 doccia / hand shower outlet 2			
	acciaio inox / stainless steel		gomma silicica / silicone rubber	
	l/min	gpm	l/min	gpm
1	8,1	2.1	6,8	1.8
2	12,3	3.3	10,1	2.7
3*	15,4	4.1	11,9	3.1
4	17,8	4.7	13,2	3.5
5	19,9	5.3	14,5	3.8

* Pressione consigliata
Recommended pressure

max. 70 °C
max. 158 °F

CEA

ceadesign.it

RICAMBI / SPARE PARTS

RICB034	Carter / Carter
RICM124	Maniglia / Handle
RICM128	Maniglia / Handle
RICR016	Rosetta / Rosette
RICR021	Rosetta / Rosette
RICR064	Rosetta / Rosette
RICT019	Raccordo / Fitting
RICU002	Supporto doccia / Hand shower holder

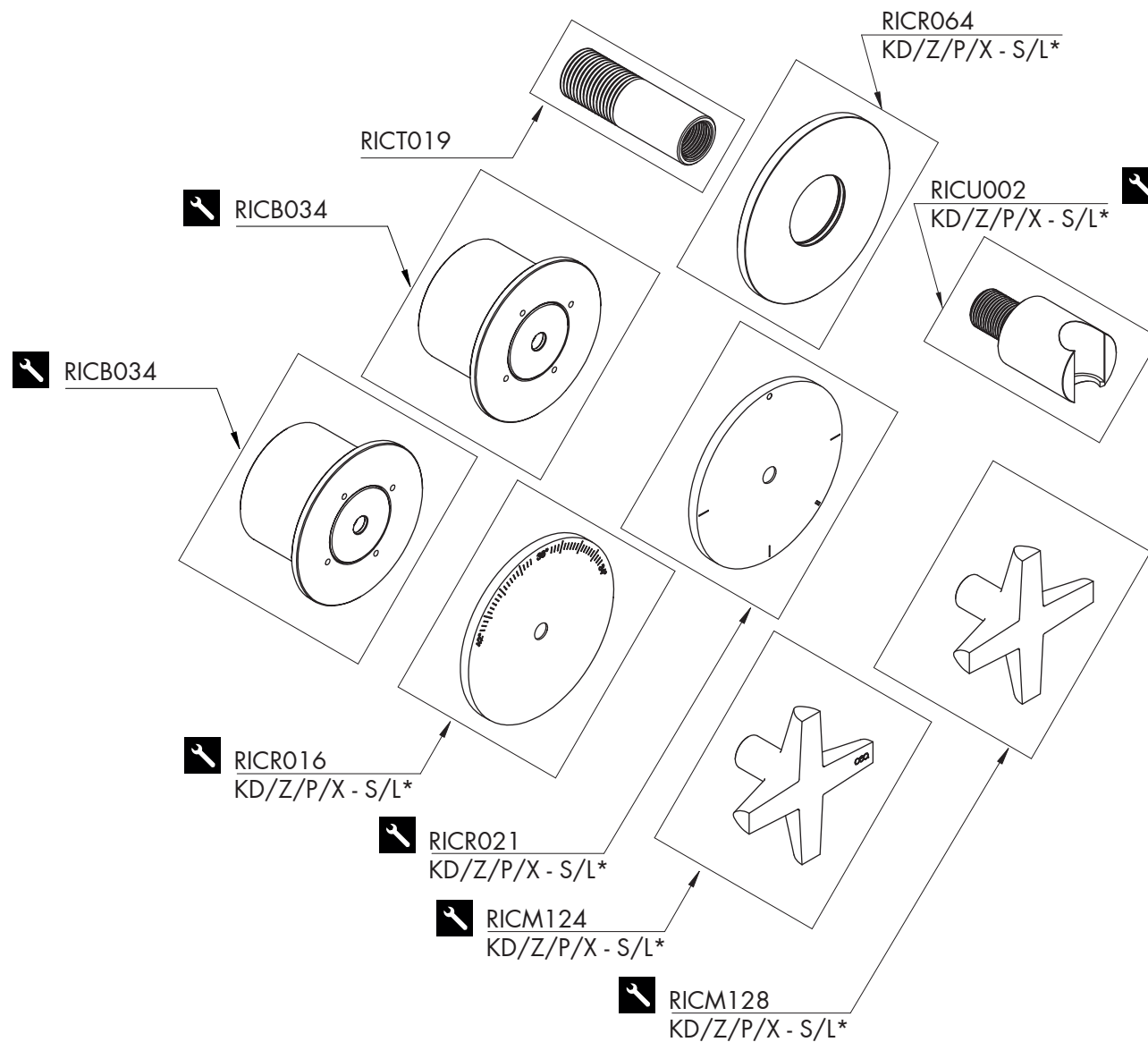

LEGENDA / LEGEND

ICONE / ICONS

 Utensile incluso nel ricambio
Tool included in spare part

FINITURE / FINISHES

*S finitura satinata / satin finish
L finitura lucidata / polished finish

FINITURE SPECIALI / SPECIAL FINISHES

KD black diamond
Z bronzo / bronze
P rame / copper
X light gold

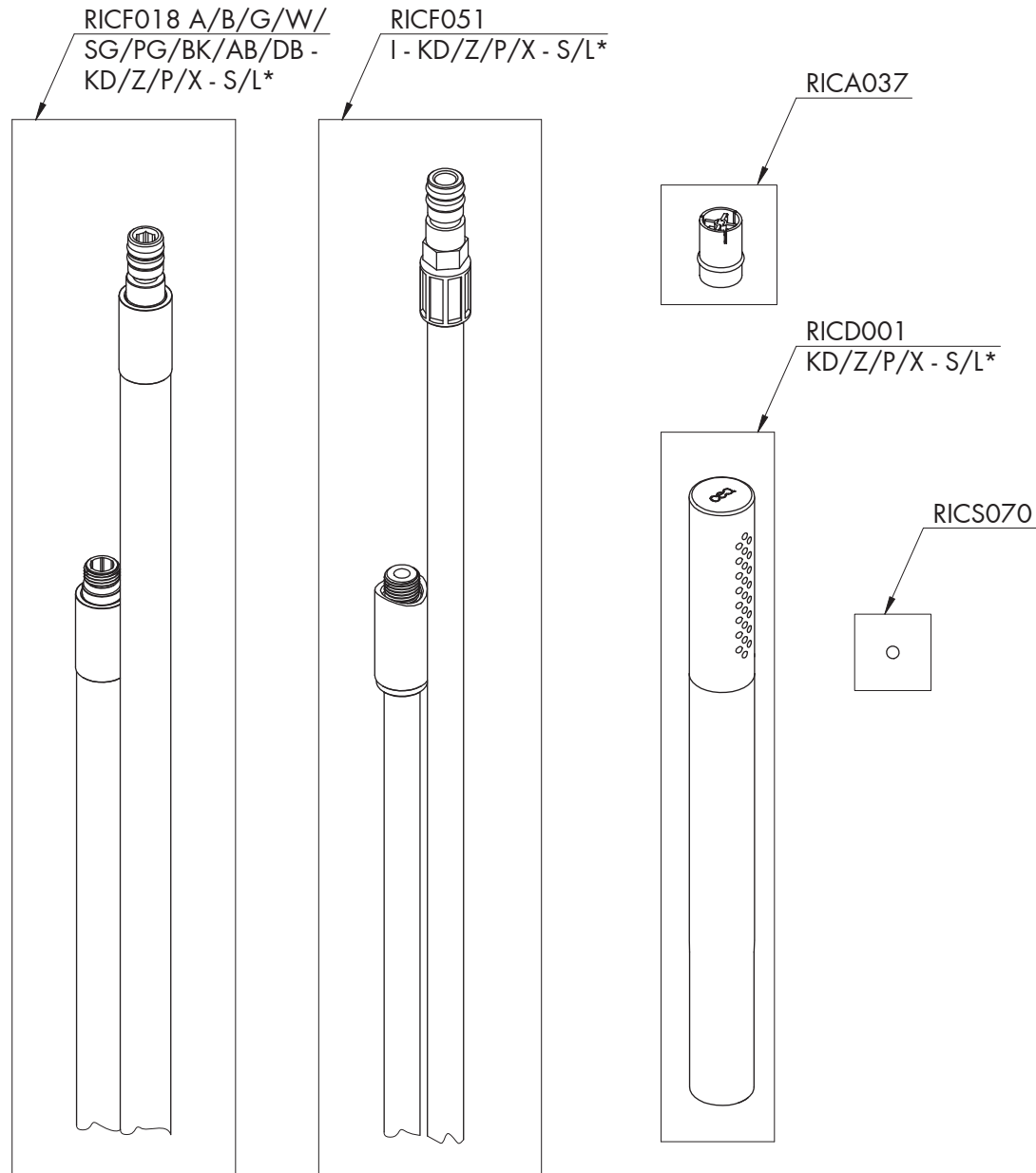

RICAMBI / SPARE PARTS

RICA037	Valvola di non ritorno / <i>Check valve</i>
RICD001	Doccino / <i>Hand shower</i>
RICF018	Flessibile / <i>Hose</i>
RICF051	Flessibile / <i>Hose</i>
RICS070	Sfera in acciaio inox Ø 3,5 mm <i>Stainless steel ball Ø 3,5 mm</i>

LEGENDA / LEGEND

ICONE / ICONS

 Utensile incluso nel ricambio
Tool included in spare part

FINITURE / FINISHES

*S finitura satinata / *satin finish*
L finitura lucidata / *polished finish*

FINITURE SPECIALI / SPECIAL FINISHES

KD black diamond
Z bronzo / *bronze*
P rame / *copper*
X light gold

COLORI FLESSIBILE / HOSE COLOURS

A	verde acqua / <i>aqua green</i>	RAL 6027
B	blu cobalto / <i>cobalt blue</i>	RAL 5013
G	grigio antracite / <i>anthracite grey</i>	RAL 7043
W	bianco / <i>white</i>	RAL 9016
SG	grigio seta / <i>silk grey</i>	RAL 7044
PG	verde petrolio / <i>petroleum green</i>	RAL 5020
BK	nero / <i>black</i>	RAL 9004
AB	blu avio / <i>air force blue</i>	RAL 5014
DB	grigio quarzo / <i>quartz grey</i>	RAL 7039
I	acciaio inox / <i>stainless steel</i>	